

15.2 - CAJA REDONDA ESTANDAR A PRUEBA DE INTEMPERIE. 102 (4). SERIE CSX.

15.2 - WEATHERPROOF 4 (102) STANDARD ROUND OUTLET BOX. CSX SERIES.

007 - RW - 275

- Material: Aluminio inyectado a presión (diecast).
- Acabados: Pintura electrostática epoxica/poliéster polimerizada.
- A prueba de intemperie cuando se usa tapa con empaque. NEMA 4,4X
- Rosca NPT para usarse con tubo conduit RIGIDO e IMC.
- Se surte con 5 bocas roscadas y 4 tapones roscados.
- Medidas de bocas: 12.7 (1/2), 19.0 (3/4)
- Tornillo de tierra pasivado incluido.
- Los agujeros sin salida para los tornillos de la tapa evitan daños al cable durante la instalación y asegura la caja a prueba de agua.

- Material: Diecast aluminum.
- Finish: Electrostatic powder epoxy/poliéster coating.
- For wet location when gasketed cover are used. NEMA 4,4X
- NPT threaded for use with RIGID and IMC conduit.
- Furnished with 5 tapped holes and 4 threaded close-up plugs.
- Hub sizes: 1/2 (12.7), 3/4 (19.0)
- Green ground screw included.
- Blank cover screw holes prevent conductor damage during installation, provide water-tightness.

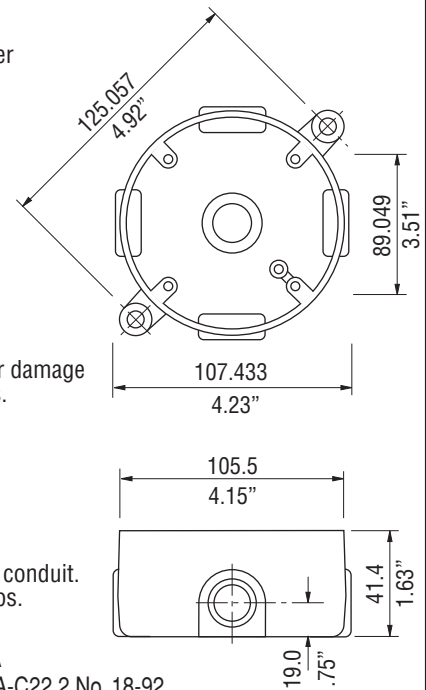

APLICACIONES.

- Caja de conexiones de uso general.
- Caja de conexiones para accesorios colgantes.
- Caja de conexiones para lampara Serie LHS.
- En instalaciones de tubo conduit RIGIDO e IMC. Permite facil acceso para mantenimiento.
- Fabricación en base a: UL 514 A
CAN/CSA-C22.2 No. 18-92

APPLICATIONS.

- Splice box for general purpose.
- Splice box for pendant fixtures.
- Splice box for lampholder LHS Series.
- In installations of threaded RIGID and IMC conduit. Provide openings for making splice and taps. Allows access for maintenance.
- Manufactured in compliance with: UL 514 A
CAN/CSA-C22.2 No. 18-92

USAR No. DE CODIGO PARA HACER PEDIDOS. TO ORDER USE CODE NUMBER.

Figura Figure	Descripción Description	Catalogo Catalog	Código Code	Salida Hub size		Peso x 100 pzas. Weight x 100 pcs.		Pqt. Unit Pzas. Pcs.	Unit Ctn. Pzas. Pcs.	Ship Ctn. Pzas. Pcs.	Std. Pkg. Pzas. Pcs.
				mm	inch	kg	lb				
	Caja redonda estandar CSX 102 (4) 5 Ø con 4 tapones	CSX-10	27.12.3353	12.7	1/2	23.0	50.7				36
	4 (102) CSX standard round outlet box 5 hubs with 4 close-up plugs.	CSX-20	27.12.3354	19.0	3/4	23.0	52.9				36
	Tapa redonda ciega TCSX 102 (4), con empaque y tornillos.	TCSX	27.12.3355			4.0	8.8	1	20	160	150
	Tapa redonda TCSX 102 (4) 1 Ø roscado, con empaque y tornillos.	TCSX-10	27.12.3356	12.7	1/2	9.3	20.5	1	6	48	70
	4 (102) TCSX round one hub cover, with gasket and screws.	TCSX-20	27.12.3357	19.0	3/4	8.6	19.0	1	6	48	70
	Tapa redonda portalampara TSX 102 (4) 3 Ø 12.7 (1/2), con empaque, tornillos y 2 tapones.	TSX	27.12.3358	12.7	1/2	14.0	30.9	1	6	48	70
	Tapón roscado. Close-up plug.	TA-0371	01.04.0371	12.7	1/2	1.0	2.2	25	200	2000	
		TA-0368	01.04.0368	19.0	3/4	1.3	2.9	25	100	1000	

Especificaciones sujetas a cambio sin previo aviso. Specifications are subject to change without notice.

RAWELT, S.A. de C.V.



Cotización/Quotation Plazo de embarque* / Shipment exw* :

 Pedido No./Purchase order :

Our ref.:

Fecha/Date: Vendedor/Salesman: No.

Facturar a/Invoice to: RFC:

Ordenado por/Ordered by: Tel. () Fax ()

Dirección/Address:







C.P./Zip: Lugar/City/Country:

Consignar a/Ship to:

 Embarcar: Camión x Cobrar Pagado Paquete

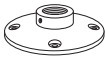
Cond. de Pago/Terms:

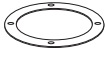
Cond. de Venta/Sale conditions: L.P.:

15.2 - SERIE CSX. CAJA REDONDA ESTANDAR A PRUEBA DE INTEMPERIE 102 (4)								
15.2 - CSX SERIES. WEATHERPROOF 4 (102) STANDARD ROUND OUTLET BOX.								
Figura Figure	Código Code	Salida Hub size		Pqt. Unit	Unit Ctn.	Ship Ctn.	Std. Pkg.	Cantidad Qty.
		mm	inch	Pzas. Pcs.	Pzas. Pcs.	Pzas. Pcs.	Pzas. Pcs.	
	27.12.3353	12.7	1/2				36	
	27.12.3354	19.0	3/4				36	
	27.12.3355			1	20	160	150	
	27.12.3356	12.7	1/2	1	6	48	70	
	27.12.3357	19.0	3/4	1	6	48	70	
	27.12.3358	12.7	1/2	1	6	48	70	
	27.11.3262			10	70	560		
	01.04.0371	12.7	1/2	25	200	2000		
	01.04.0368	19.0	3/4	25	100	1000		

 Expediente
 Control
 Embarques
 Almacén
 Producción

- Antes de fincar el pedido en firme, favor de confirmar con fábrica el plazo de embarque definitivo.
- Before place your order, please confirm with RAWELT definitive date of shipment.